



S3219E

S3220E

S3226E

S4726E

S4732E

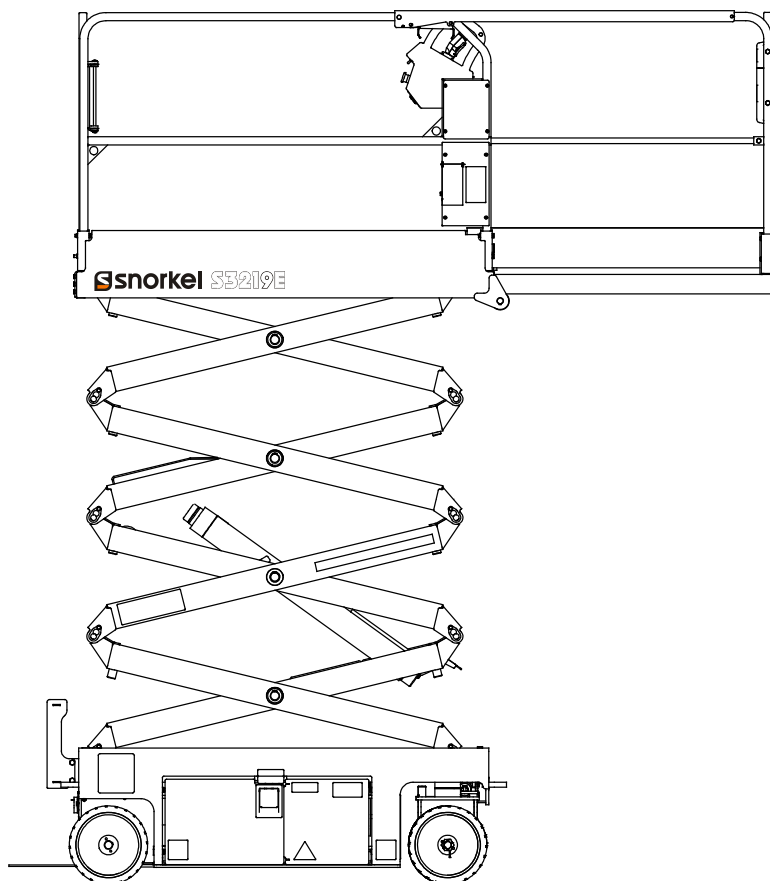

CE

OPERATORS MANUAL

Part Number 1500842
November 2015

Serial number 000000 and after
Replaces 1500842 October 2015

Table of Contents

EC Declaration of Conformity	2	Platform	12
Safety Rules	3	Raising and Lowering.....	13
Fall Restraint Lanyard Anchor Points	4	Lowering Interrupt	13
Introduction.....	5	Overload Protection	13
Component Identification.....	5	Extending	13
Special Limitations.....	6	Driving and Steering.....	13
Platform Capacity	6	Drive Range Switch	
Manual Force	6	S3226E/S3220E/S4726E/S4736E	14
Drive/Lift Pothole Protector Interlock.....	6	Drive Speeds	14
Drive/Lift Level Sensor Interlock	6	Drive/Lift Level Sensor Interlock	14
Lowering Alarm	6	Fold Down Guardrails.....	14
Lowering Interrupt	6	Swing-Out Trays.....	15
Overload Protection	6	Emergency Lowering.....	15
Beaufort Scale.....	7	Transporting the Machine.....	16
Controls and Indicators.....	8	Preparing for Transportation	16
Battery Disconnect Switch.....	9	Transporting	16
Lower Controls	9	Lifting With a Forklift.....	16
Emergency Stop Button	9	Winching	16
Control Selector/Ground Operation Switch	9	Driving	17
Platform Raise/Lower Switch	9	Hoisting	17
Upper Controls	9	Storage.....	17
Emergency Stop Button	10	Maintenance.....	18
Drive/Lift Selector Switch	10	Hydraulic Fluid	18
Joystick	10	Check Hydraulic Fluid	18
Interlock Switch	10	Battery Maintenance	18
Steer Switch	10	Battery Charging	18
Drive Range Switch		Inspection and Maintenance Schedule.....	19
S3226E/S3220E/S4726E/S4736E	10	Daily Preventative Maintenance Checklist	20
Horn Button	10	Preventative Maintenance Report.....	20
Battery Condition Indicator	10	Specifications – S3219E.....	21
Pre-Operation Safety Inspection	10	Specifications – S3220E.....	22
System Function Inspection	11	Specifications – S3226E.....	23
Operation.....	12	Specifications – S4726E.....	24
Preparing for Operation.....	12	Specifications – S4732E.....	25
Lower Controls	12		
Upper Controls	12		



Model
Modell
Modelo
Modelo

Modello
Verticaal model
Malli

SXXXXE

Serial number
Matricola
Sarajanumero

Serienummer
Numero de serie
Matricola

SXXXXE-04-XXXXXX

Notified body
Notifizierte Stelle
Organisme notifie
Organismo notificado
Aangemelde instantie
Myndighet
Aventde harmoniserde standarder
Udpeget organ
Asiasta on tehty ilmoitus seuraaville taholle
Ente Notificatore

Powered Access
Certification Ltd (PAC)
Applethwaite Lodge, The Common
Windermere
Cumbria
LA23 1JQ
United Kingdom
Notified body number 0545

EC Type Examination Certificate number
EC-Typenprufung Zertifikat-Nr
Examen type CE Numero de Certificat
Inspeccion tipo CE Numero de certificado
Atestado di certificazione CE nr
Onderzoek van het type EC Certificateaantalnummer
EU typproveringsnummer
EF-typegodkendelse Nummer pa typeattest
EU-typpitarkastuksen nr.

Signed for Snorkel

Manufacturing Quality Manager

Date

Gary Bradbury
Powered Access
Vigo Centre
Washington
Tyne and Wear
NE38 9DA
England

EC Declaration of Conformity of Machinery 2006/42/EC
EC-Konformitätserklärung für Maschinen 2006/42/EC
Declaration De Conformite CE pour les Machines 2006/42/EC
Declaracion De Conformidad CE Para Maquinaria 2006/42/EC
Dichiarazione Di Conformità CE Per Le Macchine 2006/42/EC
CE Conformiteitsverklaring voor Machine 2006/42/EC
EU Deklaration Avseende Överensstämelse För Maskinutrustning
2006/42/EC

EF-Samsvarserklæring For Maskiner 2006/42/EC
EF-Overensstemmelseserklæring for Maskiner 2006/42/EC
EU Vaatimustenmukaisuusvakuutus 2006/42/EC

Manufacturer
Hersteller
Fabricant
Fabricante
Fabbricante

Fabrikant
Tililverkare
Producent
Valmistaja

Snorkel,
Vigo Centre, Washington,
Tyne and Wear, England
Tel: +44 (0) 845 1557 755
Fax: +44 (0) 845 1557 756

Authorized Representative

Autorisierte Vertretung
Representant autorise
Representante autorizado
Mandatario
Erkend vertegenwoordiger
Auktoriserad representant
Autoriseret representant
Reprezentant
Valtuutettu edustaja

Description

Bezeichnung
Description
Descrpcion
Descrizione
Beschrijving
Beskrivning
Beskrivelse
Kuvaus

Aerial Work Platform

Arbeitsbühne
Plate-forme elevatrice de personnel
Plataforma aerea de trabajo con motor
Piattaforma di sollevamento motorizzata
Mechanisch aangedreven werkplatform
Höj-och sänkbar arbetsplattform
Selvgående arbetsplattform
Motordrevet loftepattform
Konevoimalla toimiva nostolava
Selvgående personarbetslift



SAFETY RULES

⚠Warning

All personnel shall carefully read, understand and follow all safety rules and operating instructions before operating or performing maintenance on any Snorkel aerial work platform.

Electrocution Hazard



THIS MACHINE IS NOT INSULATED!

Tip Over Hazard



NEVER elevate the platform or drive the machine while elevated unless the machine is on a firm, level surface.

Collision Hazard



NEVER position the platform without first checking for overhead obstructions or other hazards.

Fall Hazard



NEVER climb, stand, or sit on platform guardrails or midrail.

USE OF THE AERIAL WORK PLATFORM: This aerial work platform is intended to lift persons, their tools and materials used for the job. It is designed for repair, assembly, stockpicking jobs, etc., and assignments at workplaces above head height (ceilings, cranes, roof structures, buildings, shelving, etc.). All other uses of the aerial work platform are prohibited and the rules below must be adhered to!

THIS AERIAL WORK PLATFORM IS NOT INSULATED! Refer to applicable national standards for safe approach distances. Exceeding the specified permissible maximum load **is prohibited!** See “Platform Capacity” on page 6 for details.

The use and operation of the aerial work platform as a lifting tool or a crane **is prohibited!**

NEVER exceed the manual force allowed for this machine. See “Manual Force” on page 6 for details.

DISTRIBUTE all platform loads evenly on the platform.

NEVER operate the machine without first surveying the work area for surface hazards such as holes, drop-offs, bumps, curbs, or debris; and avoiding them.

OPERATE machine only on surfaces capable of supporting wheel loads.

NEVER operate the machine when wind speeds exceed this machine’s wind rating. See “Beaufort Scale” on page 7 for details.

Do not operate the aerial platform in windy or gusty conditions. Do not add anything to or take anything into the aerial platform that will increase the wind loading such as billboards, banners, flags, etc.

IN CASE OF EMERGENCY push EMERGENCY STOP switch to deactivate all powered functions.

IF ALARM SOUNDS while platform is elevated, STOP, carefully lower platform. Move machine to a firm, level surface.

Climbing up the railing of the platform, standing on or stepping from the platform onto buildings, steel or prefab concrete structures, etc., **is prohibited!**

Dismantling the entry gate or other railing components **is prohibited!** Always make certain that the entry gate is closed!

It is prohibited to keep the entry gate in an open position when the platform is raised!

To extend the height or the range by placing of ladders, scaffolds or similar devices on the platform **is prohibited!**

NEVER perform service on machine while platform is elevated without blocking elevating assembly.

INSPECT the machine thoroughly for cracked welds, loose or missing hardware, hydraulic leaks, loose wire connections, and damaged cables or hoses before using.

VERIFY that all labels are in place and legible before using.

NEVER use a machine that is damaged, not functioning properly, or has damaged or missing labels.

To bypass any safety equipment **is prohibited** and presents a danger for the persons on the aerial work platform and in its working range.

NEVER charge batteries near sparks or open flame. Charging batteries emit explosive hydrogen gas.

Modifications to the aerial work platform **are prohibited** or permissible only at the approval by **Snorkel**.

AFTER USE, secure the work platform from unauthorized use by turning the keyswitch off and removing key.

The driving of MEWP’s on the public highway is subject to national traffic regulations.

Certain inherent risks remain in the operation of this machine despite utilizing proper design practices and safeguarding.

Care must be taken to ensure that the machines meets the requirements of stability during use, transportation, assembly, dismantling when out of service, testing, or foreseeable breakdowns.

In the event of an accident or breakdown see “Emergency Lowering” on page 15, do not operate the aerial platform if it is damaged or not functioning properly. Qualified maintenance personnel must correct the problem before putting the aerial platform back into service.

Fall Restraint Lanyard Anchor Points

All fall restraint lanyard anchor points on Snorkel aerial work platforms have been tested with a force of 61.3 kN (3,650 lbs) per person.

See below examples of anchor points used on Snorkel machines with their corresponding per person rating.

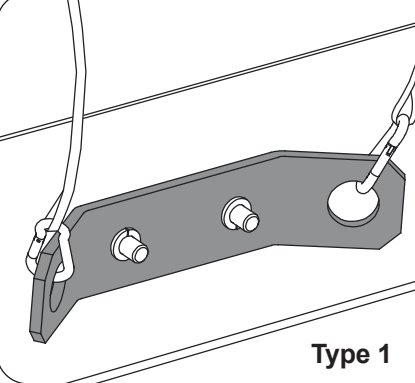
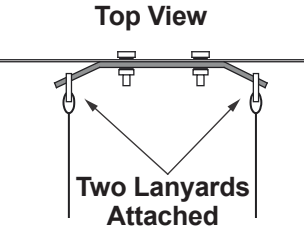
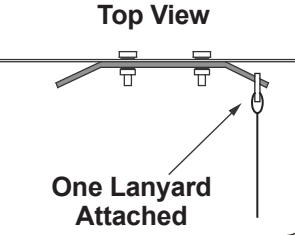
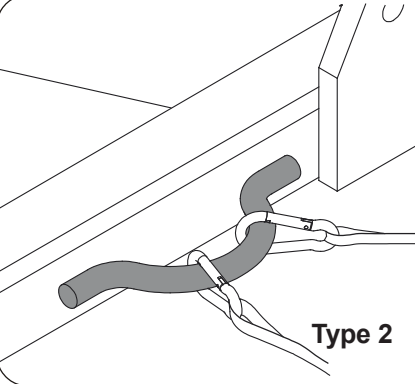
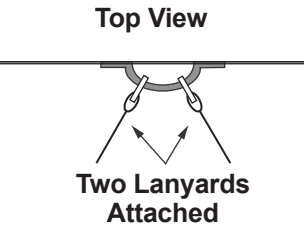
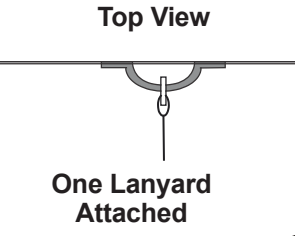
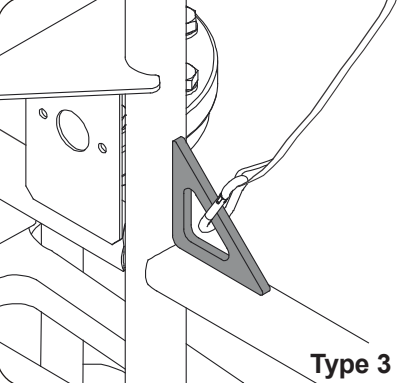
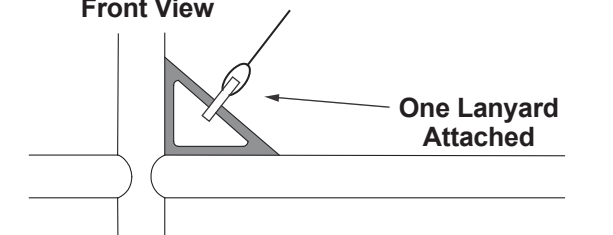
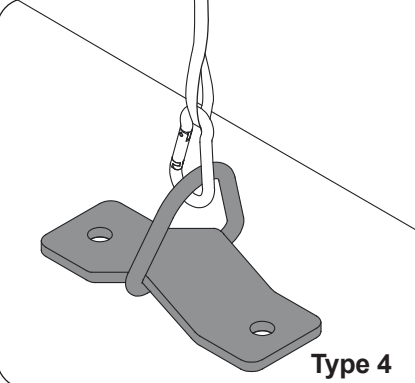
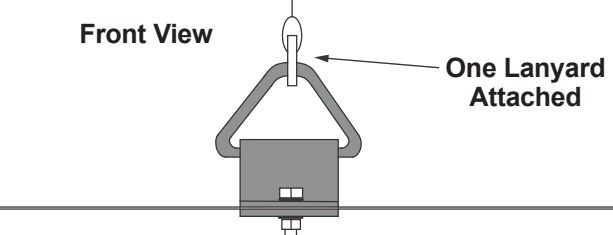
 <p style="text-align: right;">Type 1</p>	<p>Anchor point Type 1 is rated for one lanyard attachment per loop. Refer to machine "Specifications" and platform decals for maximum number of platform occupants.</p>	
	<p style="text-align: center;">Top View</p>  <p style="text-align: center;">Two Lanyards Attached</p>	<p style="text-align: center;">Top View</p>  <p style="text-align: center;">One Lanyard Attached</p>
 <p style="text-align: right;">Type 2</p>	<p>Anchor point Type 2 is rated for two lanyard attachments per loop. Refer to machine "Specifications" and platform decals for maximum number of platform occupants.</p>	
	<p style="text-align: center;">Top View</p>  <p style="text-align: center;">Two Lanyards Attached</p>	<p style="text-align: center;">Top View</p>  <p style="text-align: center;">One Lanyard Attached</p>
 <p style="text-align: right;">Type 3</p>	<p>Anchor point Type 3 is rated for one lanyard attachment per loop. Refer to machine "Specifications" and platform decals for maximum number of platform occupants.</p>	
	<p style="text-align: center;">Front View</p>  <p style="text-align: right;">One Lanyard Attached</p>	
 <p style="text-align: right;">Type 4</p>	<p>Anchor point Type 4 is rated for one lanyard attachment per loop. Refer to machine "Specifications" and platform decals for maximum number of platform occupants.</p>	
	<p style="text-align: center;">Front View</p>  <p style="text-align: right;">One Lanyard Attached</p>	

NOTE: There can be more anchor points in the platform than the maximum number of occupants allowed in the platform. Refer to the machine specifications for the correct occupancy rating before use.

Introduction

This manual covers the S3219E, S3220E, S3226E, S4726E, and S4732E Aerial Work Platforms.

This manual must be stored on the machine at all times.

Read, understand and follow all safety rules and operating instructions before attempting to operate the machine.

When contacting Snorkel for service or parts information, be sure to include the MODEL and SERIAL NUMBERS from the equipment nameplate. Should the nameplate be missing, the SERIAL NUMBER is also stamped on the front of the chassis.

Component Identification

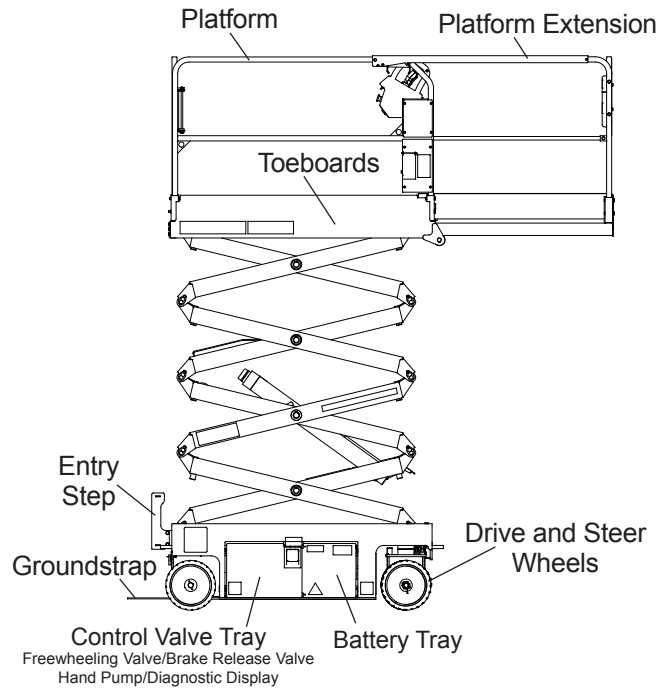

Right Side

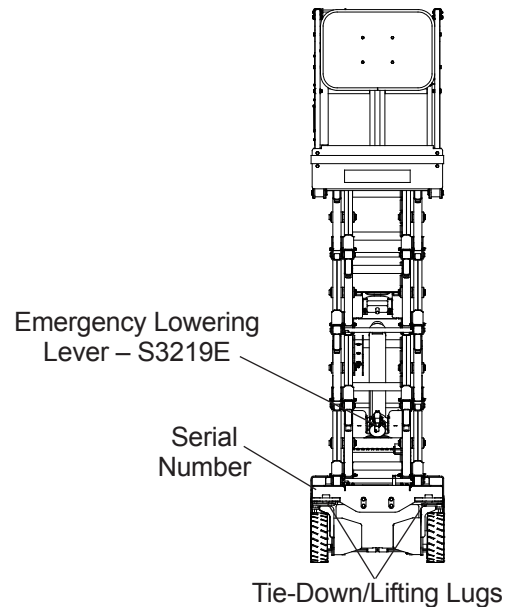

Front

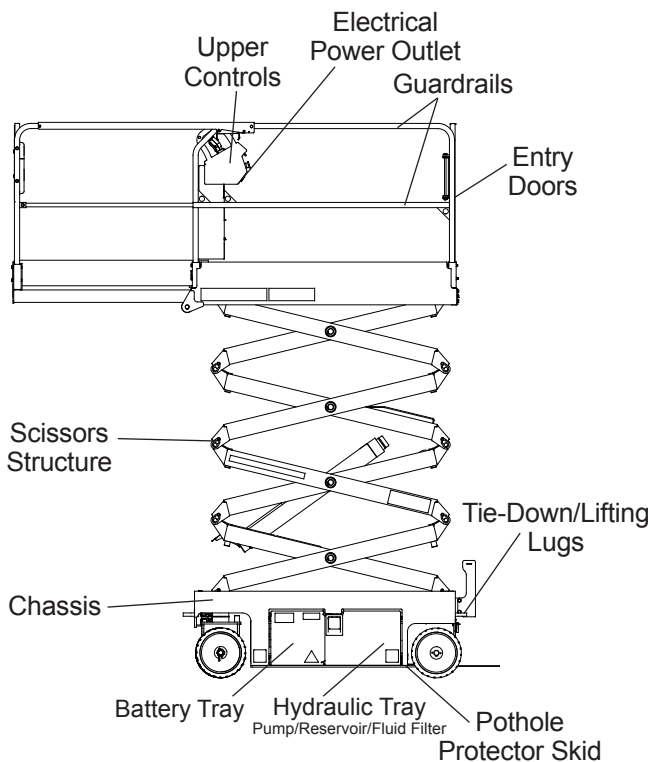

Left Side

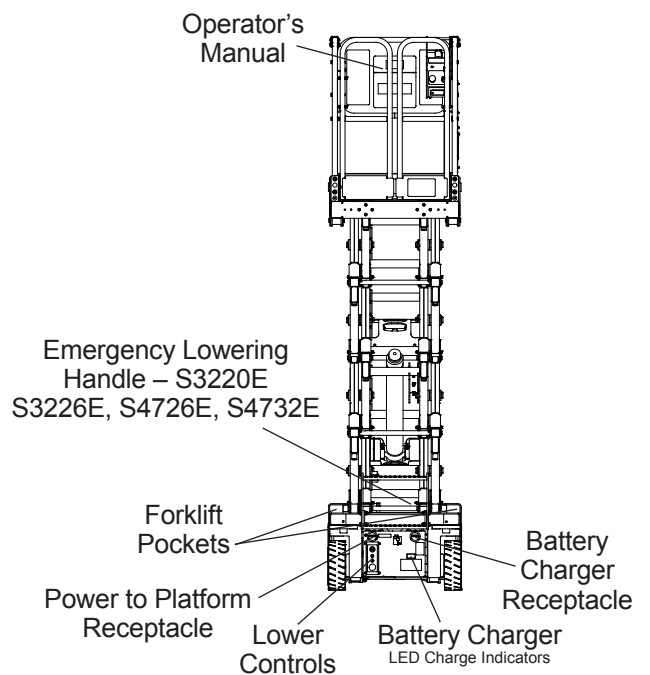

Rear

Special Limitations

Special Limitations

Travel with the platform raised is limited to creep speed range. Elevating the platform is limited to firm, level surfaces only.

Danger

The elevating function shall ONLY be used when the work platform is level and on a firm surface.

The work platform is NOT intended to be driven over uneven, rough, or soft terrain.

Platform Capacity

The maximum platform capacity for the aerial platform is stated in the “Specifications” on pages 21-25.

Danger

DO NOT exceed the maximum platform capacity or the platform occupancy limits for this machine.

Manual Force

Manual force is the force applied by the occupants to objects such as walls or other structures outside the work platform.

Refer to the platform capacity decal on the machine for specific maximum allowable manual force information.

The maximum allowable manual force varies depending on wind speed. The maximum allowable wind speed is 12.5 m/s (28 mph).

Danger

DO NOT exceed the maximum amount of manual force for this machine.

Drive/Lift Pothole Protector Interlock

The aerial platform drive and lift functions are interlocked through a limit switch inside the chassis that senses whether or not the pothole protection linkage is locked into position. The drive/lift pothole interlock operates when the platform is elevated approximately 1.8 m (6').

If an obstruction under the skids, or some other impairment prevents the skids from locking into position, the drive and steer functions will not operate and an alarm will sound.

Lower the platform and remove the obstruction when the drive/lift pothole protector interlock alarm sounds.

Drive/Lift Level Sensor Interlock

The aerial platform drive and lift functions are interlocked through a level sensor system. The drive/lift level sensor interlock operates when the platform is elevated approximately 1.8 m (6').

If the chassis is tilted too far out of level, the drive and lift functions will not operate and an alarm will sound. Refer to the machine specifications for the level sensor factory setting.

Lower the platform and drive to a level surface when the drive/lift level sensor alarm sounds.

The drive/lift level sensor system is for added protection and does not justify operating on anything other than firm, flat, level surfaces.

Lowering Alarm

When the joystick is moved out of neutral to lower the platform, the alarm emits a loud beeping sound to warn personnel in the work area to stand clear.

Danger

Pinch points exist on the scissors structure. Death or serious injury will result if the scissors structure lowers onto personnel within the scissors arms or under the raised platform. Stand clear while raising and lowering the platform.

Be careful when lowering the platform. Keep hands and fingers away from the scissors structures components.

Lowering Interrupt

When the platform is lowered to about 1.8 m (6') lowering stops. The platform will not lower for five seconds regardless of the control position to allow personnel to clear the area of the scissors before the platform completely lowers.

Center the control in neutral to reset the lowering function, then continue to lower the platform.

When the platform is below 1.8 m (6') and the control is moved to lower the platform, there is a 1.5 second delay before movement begins.

Overload Protection

When the load in the platform is near or at rated capacity, an alarm will sound and the red light on the lower controls will flash.

The alarm and light warn the operator that the platform is close to becoming overloaded. All functions remain fully operational.

Danger

The aerial platform can tip over if it becomes unstable. Death or serious injury will result from a tip-over accident. Do not exceed the capacity values indicated on the platform rating placard.

If the platform is fully lowered and is overloaded, when it is elevated just past 1.8 m (6'), a control module will stop the lift and drive functions and the alarm will sound and the warning light will flash. The platform can still be lowered to remove the excess load.

If the platform is elevated just past 1.8 m (6') and material is added to the platform overloading it, a control module will stop the lift, drive and lower functions and the alarm will sound and the warning light will flash. In this case, remove the load in excess of rated capacity and cycle

the emergency stop button at the upper controls to return to normal operation.

Beaufort Scale

Never operate the machine when wind speeds exceed 12.5 m/s (28 mph) [Beaufort scale 6]. Refer to Figure 1.

BEAUFORT RATING	WIND SPEED				GROUND CONDITIONS
	m/s	km/h	ft/s	mph	
3	3,4~5,4	12,25~19,4	11.5~17.75	7.5~12.0	Papers and thin branches move, flags wave.
4	5,4~8,0	19,4~28,8	17.75~26.25	12.0~18	Dust is raised, paper whirls up, and small branches sway.
5	8,0~10,8	28,8~38,9	26.25~35.5	18~24.25	Shrubs with leaves start swaying. Wave crests are apparent in ponds or swamps.
6	10,8~13,9	38,9~50,0	35.5~45.5	24.5~31	Tree branches move. Power lines whistle. It is difficult to open an umbrella.
7	13,9~17,2	50,0~61,9	45.5~56.5	31.~38.5	Whole trees sway. It is difficult to walk against the wind.

Figure 1 – Beaufort Scale

Controls and Indicators

The operator shall know the location of each control and indicator and have a thorough knowledge of the function and operation of each before attempting to operate the machine.

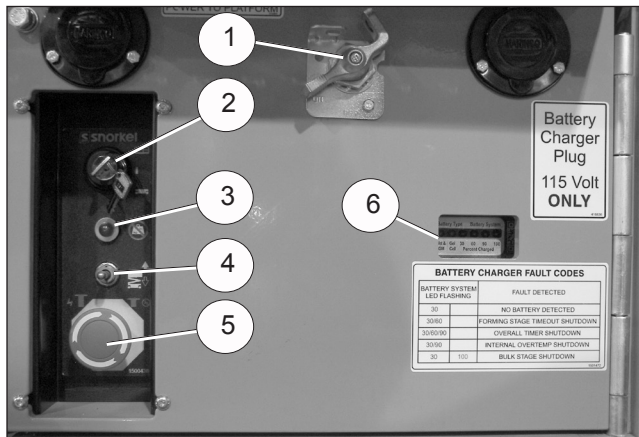

Figure 2 – Rear of Chassis

1. Battery disconnect switch
2. Control selector/ground operation switch
3. Platform overload protection light
4. Platform raise/lower switch
5. Emergency stop button
6. Battery charger codes
7. Battery condition indicator
8. Interlock switch
9. Joystick
10. Steer switch
11. Drive range switch – S3220E/S3226E/S4726/S4732E
12. Drive/lift selector switch
13. Horn button

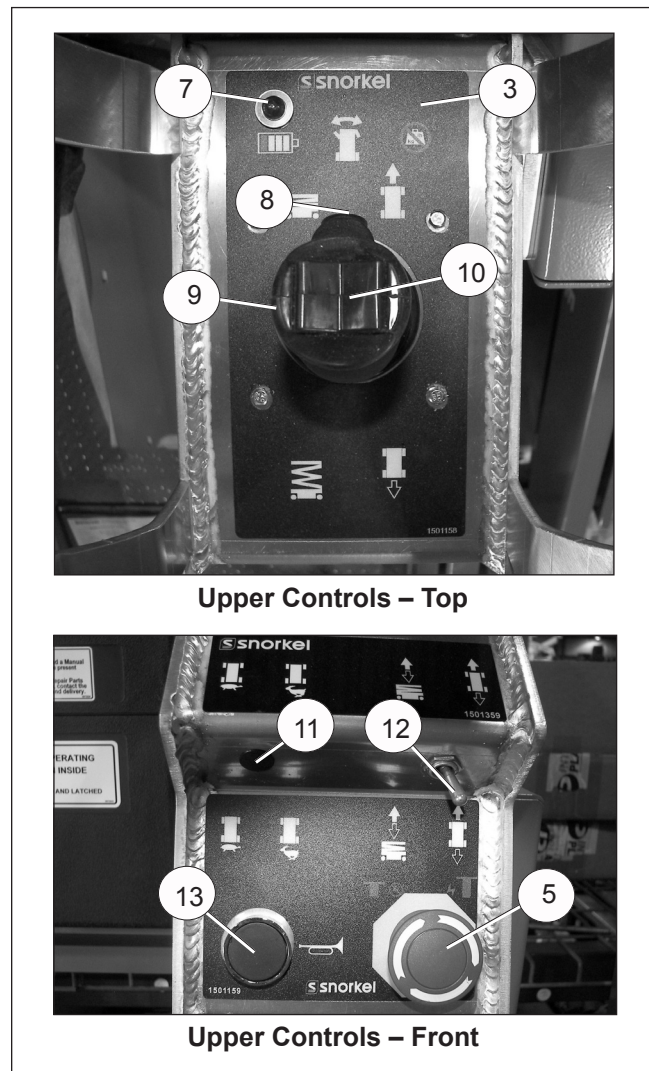

Figure 3 – Upper Controls and Indicators

⚠ Danger

Pinch points may exist between moving components. Death or serious injury will result from becoming trapped between components, buildings, structures, or other obstacles. Make sure all personnel stand clear while operating the aerial platform.

- Controls to position the platform are located on the lower control panel on the chassis and on the upper control panel in the platform.
- Controls to drive the aerial platform are located on the upper control panel only.

The diagnostic center LCD display is located in the hydraulic tray next to the fluid reservoir (refer to Figure 4).

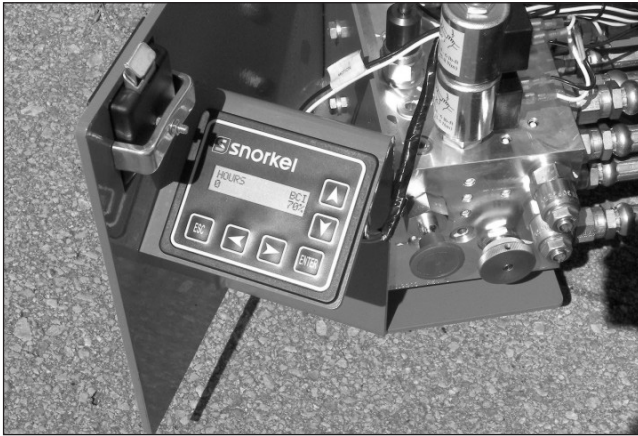

Figure 4 – Diagnostic Center LCD Display

The LCD display shows the accumulated aerial platform operating time and the available battery power to operate the machine, when the battery disconnect and emergency stop switch are in the on position.

Battery Disconnect Switch

The battery disconnect switch is located at the rear of the chassis (refer to Figure 2).

The battery disconnect removes electrical power from all electrically controlled functions when in the off position.

- Place the switch in the on position to electrically connect the battery to the electrical system.

⚠ Caution

Only authorized personnel should operate the aerial platform. Unqualified personnel may cause injury to coworkers or property damage. Lock the battery disconnect switch in the off position before leaving the aerial platform unattended.

- Lock the battery disconnect switch in the off position to prevent unauthorized use of the aerial platform.

Lower Controls

The lower controls (refer to Figure 2) are located at the rear of the chassis. Only platform functions can be operated from the lower controls.

The following are located on the lower control panel:

- Emergency stop button
- Control selector/ground operation switch
- Platform raise/lower switch
- Platform overload protection light

Emergency Stop Button

The emergency stop is a two-position red push button.

- Push the button inward to disconnect power to all control circuits.
- Twist the button to restore power.

Control Selector/Ground Operation Switch

Insert the key into the control selector/ground operation switch.

- In the upper position, aerial platform functions will not operate from the lower or upper controls.
- Turn the switch to the upper controls position to operate the aerial platform functions from the upper controls.
- Hold the switch downward continually in the lower controls position to enable the platform raise/lower switch functions. The switch is spring returned to the off position.

The upper controls will not operate while the control selector is in the lower position.

Platform Raise/Lower Switch

The platform raise/lower switch is used to raise or lower the platform. The switch is spring returned to the center off position.

- Hold the switch upward to raise the platform.
- Hold the switch downward to lower the platform.
- An alarm will sound as the platform lowers.

Upper Controls

The upper controls (refer to Figure 3) are located on the control panel at the platform. Platform and drive functions can be operated from the upper controls.

⚠ Warning

The potential for an accident increases from improperly driving or steering the aerial platform. Death or serious injury could result from such accidents. Make sure the upper control panel is securely fastened inside the platform and facing the front of the machine.

Avoid driving the platform with the upper controls facing the rear or side of the machine. In this position the machine is difficult to control because the drive and steer control movements and their resulting machine movements will not correspond.

Only operate the upper controls when the upper control panel is securely fastened inside the platform and facing the front of the machine.

The following are located on the upper control panel:

- Emergency stop button
- Drive/lift selector switch
- Drive range switch – S3220E/S3226E/S4726/S4732E
- Joystick to control platform lift, drive, and steer
- Horn button
- Battery condition indicator
- Platform overload protection light

Pre-Operation Safety Inspection

Emergency Stop Button

The emergency stop (refer to Figure 3) is a two-position, red push button on the front of the upper control panel.

- Push the button inward to disconnect power from all control circuits at the upper controls.
- Twist the button to restore power.
- Push the emergency stop button inward when the upper controls are not in use to protect against unintentional operation.

Note

The lower controls override the upper controls. If the upper control emergency stop is engaged the lower controls can still be used to operate the aerial platform.

Drive/Lift Selector Switch

The drive/lift selector switch (refer to Figure 3) is used to select either machine drive or lift functions. Both functions can not be operated at the same time.

- Place the drive/lift selector switch in the drive position to drive the aerial platform using the joystick. The platform will not raise or lower while driving.
- Place the drive/lift selector switch in the lift position to raise and lower the platform using the joystick.

Joystick

Use the joystick (refer to Figure 3) to operate the following functions:

- Aerial platform steering
- Aerial platform drive and speed
- Platform raise/lower and speed

Movement of the joystick in a given direction produces a corresponding movement of the aerial platform. The steering and drive functions may be operated separately or simultaneously.

Interlock Switch

The joystick has an interlock switch in the handle (refer to Figure 3).

- Engage the interlock by grasping the joystick and pulling the switch toward the handle.
- Engage the interlock to activate the steering, drive, or lift functions.

Steer Switch

The steer switch (refer to Figure 3) is a momentary contact, rocker switch on top of the drive joystick. This switch controls the two front wheels to steer the aerial platform.

- To steer to the right, engage the interlock switch on the joystick and hold down the right side of the steer switch.

- To steer to the left, engage the interlock switch on the joystick and hold down the left side of the steer switch.

Note

The steering wheels are not self-centering. Set the steering wheels straight ahead after completing a turn.

Drive Range Switch

S3220E/S3226E/S4726E/S4732E

The drive range switch (refer to Figure 3) has two positions to select drive wheel operation:

- High (Rabbit) – for normal driving conditions
- Low (Turtle) – for driving on grades up to 25 percent that require low speed and high torque operation, where high range is not sufficient to climb the grade.

Horn Button

The horn button (refer to Figure 3) is on the front of the upper control panel.

Press the button to sound the horn.

Battery Condition Indicator

The battery condition indicator (refer to Figure 3) is located on the top of the upper control panel. When the light comes on, the lift function is cut out and drive speed is reduced to slow.

Pre-Operation Safety Inspection

Note

Carefully read, understand and follow all safety rules, operating instructions, labels and National Safety Instructions/Requirements. Perform the following steps each day before use.

1. Open the trays and inspect for damage, fluid leaks or missing parts.
2. Check the level of the hydraulic fluid with the platform fully lowered. The fluid level must be between the full and add marks. Add recommended hydraulic fluid if necessary. See "Specifications" on pages 21-25.
3. Check that the fluid level in the batteries is correct. See "Battery Maintenance" on page 18.
4. Verify that the batteries are charged.
5. Check that the AC extension cord has been disconnected from the outlet on the side of the chassis.
6. Check that all guardrails are in place and all fasteners are properly tightened.
7. Inspect the machine thoroughly for cracked welds and structural damage, loose or missing hardware, hydraulic leaks, damaged control cable and loose wire connections.

System Function Inspection

Refer to “Controls and Indicators” on page 8 for the locations of various controls and indicators.

 Warning

STAND CLEAR of the work platform while performing the following checks.

Before operating the machine, survey the work area for surface hazards such as holes, drop-offs, bumps and debris.

Check in ALL directions, including above the work platform, for obstructions and electrical conductors.

1. Move the machine, if necessary, to an unobstructed area to allow for full elevation.
2. Twist the Lower Control Emergency Stop Switch to the ON position.
3. Twist the Upper Control Emergency Stop Switch to the ON position.
4. Visually inspect the elevating assembly, lift cylinder, and hoses for cracked welds and structural damage, loose hardware, hydraulic leaks, loose wire connections, and erratic operation. Check for missing or loose parts.
5. Hold the ground operation switch downward. Test each machine function from the lower control station (refer to Figure 2).
6. Test the emergency lowering system for proper operation.
7. Push the Lower Control Emergency Stop Button to check for proper operation. All machine functions should be disabled. Twist the Lower Control Emergency Stop Button outward to resume.
8. Enter the platform and close the gate.
9. Check that the route is clear of obstacles (persons, obstructions, debris), is level, and is capable of supporting the wheel loads.
10. Test each machine function from the upper control station by engaging the interlock and operating the function controls (refer to Figure 3).
11. Push the Upper Control Emergency Stop Button to check for proper operation. All machine functions should be disabled. Twist the Upper Control Emergency Stop Button to resume.

Operation

The aerial platform may be operated from either the lower or upper controls.

Danger

The aerial platform is not electrically insulated. Death or serious injury will result from contact with, or inadequate clearance from, an energized conductor. Do not go closer than the minimum safe approach distance as defined by ANSI or national safety regulations.

Pinch points may exist between moving components. Death or serious injury will result from becoming trapped between components, buildings, structures, or other obstacles. Make sure there is sufficient clearance around the machine before moving the chassis or platform. Allow sufficient room and time to stop movement to avoid contact with structures or other hazards.

The aerial platform can tip over if it becomes unstable. Death or serious injury will result from a tip-over accident. Operate the aerial platform on a firm, flat, level surface. Avoid travel speeds and/or rough terrain that could cause sudden changes in platform position. Do not drive or position the aerial platform for elevated use near any drop-off, hole, slope, soft or uneven ground, or other tip-over hazard. Do not operate the aerial platform in unapproved locations or wind conditions.

The platform rated work load is the total weight of the personnel and equipment that may be lifted in the platform.

The work loads are stated on the platform rating placard at the entrance to the platform.

Danger

The aerial platform can tip over if it becomes unstable. Death or serious injury will result from a tip-over accident. Do not exceed the capacity values indicated on the platform rating placard.

Capacity values indicate the rated lifting capacity and do not indicate aerial platform stability.

The operator bears ultimate responsibility for ensuring that the aerial platform is properly set up for the particular conditions encountered.

Preparing for Operation

Use the following procedure to prepare the aerial platform for operation:

1. Perform a pre-operation safety and system function inspection.
2. Close and latch the control valve, hydraulic, and battery trays.
3. Place the battery disconnect switch in the on position.

Lower Controls

Only the platform raise and lower functions may be operated from the lower controls. The lower controls may be used for initial set up of the aerial platform, and for testing and inspection.

Use the following procedure to raise or lower the platform using the lower controls.

1. Twist the emergency stop button (refer to Figure 2).
2. Insert the key into the control selector/ground operation switch and turn the switch to the lower controls position. Hold the switch in the lower controls position.
3. Hold the platform raise/lower toggle switch up to raise the platform and down to lower it.
4. Release the toggle switch to stop movement.

Upper Controls

The upper controls may be used for driving and positioning the aerial platform while on the job.

Before operating the upper controls, properly set up the aerial platform as described under Preparing for Operation.

Use the following procedure to operate the aerial platform from the upper controls:

1. From the lower controls, twist the emergency stop button to restore power (refer to Figure 2).
2. Insert the key into the control selector switch and turn the switch to the upper controls position.

Note

The upper controls will not operate while the control selector is in the lower position.

3. Enter the platform and secure the gate.
4. From the upper controls, twist the emergency stop button to restore power (refer to Figure 3).
5. The aerial platform may be driven and the platform may be raised and lowered from the upper controls.

Platform

Use care when entering and exiting the platform to avoid slipping and/or falling. Securely close the safety gate when the platform is occupied.

Danger

The potential for an accident increases when the fold down rails are lowered. Death or serious injury can result in such accidents. Do not elevate the platform with the fold down rails lowered. Use extreme care when moving the aerial platform while the fold down rails are lowered.

Be sure the fold down guardrails are up and the hardware is securely tightened, anytime the machine is not being transported.

Raising and Lowering

The raise speed is proportional to the joystick position. The farther the joystick is moved, the faster the platform raises. There is only one lowering speed.

1. Place the drive/lift selector switch (refer to Figure 3) in the lift position.
2. Squeeze and hold the interlock switch against the joystick.
 - To raise the platform, slowly pull the joystick backward, until the desired height is reached.
 - To lower the platform, push the joystick forward.

Lowering Interrupt

When the platform is lowered to about 1.8 m (6') lowering stops. The platform will not lower for five seconds regardless of the joystick position.

Center the control in neutral to reset the lowering function, then continue to lower the platform.

When the platform is below 1.8 m (6') and the control is moved to lower the platform, there is a 1.5 second delay before movement begins.

Overload Protection

When the load in the platform is near or at rated capacity, an alarm will sound and the red light on the upper controls will flash.

The alarm and light warn the operator that the platform is close to becoming overloaded. All functions remain fully operational.

Danger

The aerial platform can tip over if it becomes unstable. Death or serious injury will result from a tip-over accident. Do not exceed the capacity values indicated on the platform rating placard.

If the platform is fully lowered and is overloaded, when it is elevated just past 1.8 m (6'), a control module will stop the lift and drive functions and the alarm will sound and the warning light will flash. The platform can still be lowered to remove the excess load.

If the platform is elevated just past 1.8 m (6') and material is added to the platform overloading it, a control module will stop the lift, drive and lower functions and the alarm will sound and the warning light will flash. In this case, remove the load in excess of rated capacity and cycle the emergency stop button at the upper controls to return to normal operation.

Extending

The platform can be extended and securely locked into position.

Use the following procedure to extend the platform:

1. Enter the platform and close the gate.

Caution

The extension deck is free to move when the extension handle locks are disengaged. Personal injury may result from accidentally extending or retracting the deck. Make certain both extension handle locks are fully engaged when the deck is extended in the working position and when it is stowed. Do not attempt to extend or retract the platform unless the aerial platform is on a level surface.

2. While facing the front of the platform, grasp the platform extension handles, raise them and push the extension deck forward to extend the deck. Fully lower the handles at the mid or front position and ensure they are locked in their lowered position.
3. Try to move the rails back and forth to make sure the platform extension deck is locked in position.

Use the following procedure to retract the platform:

1. Enter the platform and close the gate.

Caution

The extension deck is free to move when the extension handle locks are disengaged. Personal injury may result from accidentally extending or retracting the deck. Make certain both extension handle locks are fully engaged when the deck is extended in the working position and when it is stowed. Do not attempt to extend or retract the platform unless the aerial platform is on a level surface.

2. While facing the front of the platform, grasp the platform extension handles, raise them and pull the extension deck backward to retract the deck. Fully lower the handles at the stowed position and ensure they are locked in the lowered position.
3. Try to move the rails back and forth to make sure the platform extension deck is locked in position.

Driving and Steering

Danger

The aerial platform can tip over if it becomes unstable. Death or serious injury will result from a tip-over accident. Do not drive an elevated aerial platform on soft, uneven, or sloping surfaces. Do not drive on grades that exceed 25 percent.

Operation

A fully stowed machine may be operated on grades up to 25 percent. A grade of 25 percent is a 0.76 m (30") vertical rise in 3.05 m (10') horizontal length.

Warning

Death or serious injury could result from improperly driving or steering the aerial platform. Read and understand the information in this manual and on the placards and decals on the machine before operating the aerial platform on the job.

Use the following procedure to operate the drive and steer functions.

1. Place the drive/lift selector switch (refer to Figure 3) in the drive position.
2. Push the drive joystick forward to move the chassis forward. Pull the joystick backward to move the chassis backward. The drive speed is proportional to the joystick position.
3. To stop drive motion, return the joystick to neutral.

Note

To make an emergency stop push the emergency stop button inward to apply the parking brakes.

4. The steer switch is a momentary contact, rocker switch on top of the drive joystick. This switch controls the two front wheels to steer the aerial platform.
 - To steer to the right, hold down the right side of the steer switch.
 - To steer to the left, hold down the left side of the steer switch.

Note

Holding the steer switch down too long may result in a sharp turn. This is especially true when driving and steering at the same time. It may be easier to turn the wheels in small increments using a series of quick taps on the steer switch.

5. Set the steer wheels straight ahead after completing a turn. The steering wheels are not self-centering.

Drive Range Switch

S3220E/S3226E/S4726E/S4732E

The drive range switch has two positions to select drive wheel operation:

- High (Rabbit) – for normal driving conditions.
- Low (Turtle) – for driving on grades up to 25 percent that require low speed and high torque operation, where high range is not sufficient to climb the grade.

In high the machine will travel up to 3.2 km/h (2 mph) when the platform is raised less than 2.4 m (8') and up to 0.6 km/h

(0.4 mph) when the platform is raised above 2.4 m (8'). Place the drive range switch in high for normal machine operation.

Caution

The extension deck is free to move when the extension handle locks are disengaged. Personal injury may result from accidentally extending or retracting the deck. Make certain both extension handle locks are fully engaged when the deck is extended in the working position and when it is stowed. Do not attempt to extend or retract the platform unless the aerial platform is on a level surface.

Place the drive range switch in low, with the platform fully lowered and the extension deck securely pinned, before driving up a ramp to load the machine for transport.

Drive Speeds

The drive speed is proportional to the joystick position. The farther the joystick is moved, the faster the travel speed.

Always slow down before traveling over rough terrain or any sloped surface.

Drive speed ranges are interlocked through limit switches that sense the platform position.

- When the platform is elevated below approximately 1.8 m (6') the aerial platform may be driven with the full range of drive speeds.
- When the platform is elevated above 1.8 m (6') only the slowest drive speed will work.

Warning

The potential for an accident increases when safety devices do not function properly. Death or serious injury could result from such accidents. Do not alter, disable, or override any safety device.

Do not use the aerial platform if it drives faster than 0.6 km/h (0.4 mph), which is 5.3 m (7' 7") in 30 seconds, when elevated above 1.8 m (6').

Drive/Lift Level Sensor Interlock

When the platform is elevated above 1.8 m (6'), lift and drive functions are interlocked through a level sensor system. If the chassis is tilted more than specified side-to-side or front-to-rear (refer to "Specifications" on pages 21-25), platform raise and drive functions are disabled and an alarm sounds when those controls are activated.

If the drive/lift level sensor interlock shuts off the platform raise and drive functions, lower the platform and drive to a level surface.

Fold Down Guardrails

The platform guardrails may be folded down to pass the machine under low height obstructions.

⚠ Danger

The potential for an accident increases when the fold down rails are lowered. Death or serious injury can result in such accidents. Do not elevate the platform with the fold down rails lowered. Use extreme care when moving the aerial platform while the fold down rails are lowered.

Use the following procedure to lower the platform guard-rails.

1. Remove all materials from the platform floor and retract the extension deck.
2. Remove the pin from the hinged top rail on the extension deck. Fold the hinged rail in as far as it will go.
3. Lift the left hand extension deck rail up and fold it down inwards.
4. Remove the pin from the hinged top rail on the main deck. Fold the hinged rail in as far as it will go.
5. Lift the left hand main deck rail up and fold it inwards.
6. Lift the right hand extension deck rail up and fold it down inwards.
7. Lift the right hand main deck rail up and fold it inwards.
8. Reverse this procedure to reposition the rails.

Swing-Out Trays

Batteries and hydraulic components are enclosed in swing-out trays on each side of the chassis.

- The battery trays each contain two batteries. There is a battery tray at the front of the machine, both sides of the chassis.
- The control valve tray on the right side of the chassis contains the hydraulic control valve with the free-wheeling valve, brake release valve and the brake hand pump. The diagnostic center LCD display is also in this tray.
- The hydraulic tray on the left side of the chassis contains the hydraulic pump, reservoir and fluid filter.

⚠ Danger

The aerial platform can tip over if it becomes unstable. Death or serious injury can result from a tip-over accident. Do not open the trays when the platform is raised more than eight feet.

- To open a tray, pull upward on the latch and swing the tray open.
- The latched tray must be opened first, before the battery tray can be opened.
- When closing the trays, close the battery tray first. The

latched tray holds both trays in the closed position.

Emergency Lowering

Use the following procedure to operate the emergency lowering system.

⚠ Warning

The potential for an accident increases when safety devices do not function properly. Death or serious injury can result from such accidents. Immediately push the emergency stop button inward to disable the control system before using the emergency lowering system in the event of an emergency.

1. Immediately push the emergency stop button inward to disable the control system in the event of an emergency.
2. Retract the platform extension deck if possible.
3. While standing clear of the scissors structure:
 - S3219E – push downward on the emergency lowering lever at the front of the machine to lower the platform.
 - S3220E/S3226E/S4726E/S4732E – pull outward on the emergency lowering handle at the rear of the machine to lower the platform.
4. Make certain the lever/handle is fully released and the emergency lowering valve is fully closed before operating the aerial platform.

Transporting the Machine

Transporting the Machine

Preparing for Transportation

Use the following procedure to prepare the aerial platform for transportation.

1. Remove any unnecessary tools, materials, or other loose objects from the platform.
2. Close and latch the battery trays and cowling doors.

Transporting

The aerial platform may be moved on a transport vehicle. Depending on the particular situation, the aerial platform may be lifted with a forklift, driven, winched, or hoisted onto a vehicle such as a truck or trailer. Lifting with a forklift is the preferred method.

The equipment used to load, unload, and transport the aerial platform must have adequate capacity. The empty vehicle weight is listed in “Specifications” on pages 21 to 25 and is stamped on the serial number placard.

The user assumes all responsibility for:

- Choosing the proper method of transportation.
- Choosing the proper selection and use of transportation and tie-down devices.
- Making sure the equipment used is capable of supporting the weight of the aerial platform.
- Making sure all manufacturer's instructions and warnings, regulations and safety rules of their employer, the DOT, and/or any other state or federal law are followed.

Lifting With a Forklift

Use the following procedure to lift the aerial platform with a forklift.

1. Properly stow the aerial platform.
2. Remove all personnel, tools, materials, or other loose objects from the platform.
3. If lifting from the rear of the machine, insert the forklift forks into the pockets.

Caution

Lifting the aerial platform with the forklift forks positioned improperly can produce enough force to damage machine components. When lifting the machine from the side, place the forklift forks directly under the designated lift points.

4. If lifting from either side of the machine, place the forklift forks directly under the tray hinges and beneath the pothole protector skid.
5. Do not raise the aerial platform higher than necessary

to transport it. Drive the forklift slowly and carefully when transporting the aerial platform.

Winching

Use a winch to load and unload the aerial platform on ramps that exceed the gradeability specification for the machine. Refer to “Specifications” pages 21 to 25. A winch may also be used when poor traction, uneven surfaces, or stepped ramp transition make driving hazardous.

Use the following procedure to winch the aerial platform onto the transport vehicle.

1. Position the transport vehicle so the aerial platform will not roll forward after it is loaded.
2. Remove any unnecessary tools, materials, or other loose objects from the platform.
3. Drive the machine to the foot of the loading ramp with the front wheels nearest the ramp. Make sure the machine is centered with the ramps and that the steering wheels are straight.
4. Properly stow the aerial platform.

Warning

The aerial platform is free to move when the brakes are released. Death or serious injury can result. Re-enable the brakes before operating the aerial platform.

5. Chock the wheels to prevent uncontrolled motion of the aerial platform.
6. Unlatch and swing out the control valve tray on the right side of the machine. The brake release valve, pump, and free-wheeling valves are located on the hydraulic manifold. Press downward on the brake release valve to the fully open position.
7. Turn the free-wheeling valve counterclockwise to the fully open position. Push and release the brake release pump knob several times to release the brakes.
8. Attach the winch line to the tie-down lugs on the front of the chassis.
9. Remove the wheel chocks and use the winch to position the aerial platform on the transport vehicle.
10. Pull upward on the brake release valve and close the free-wheeling valve.
11. Drive the aerial platform forward or reverse and then stop to reset the parking brakes.
12. Verify that the drive system and brakes operate properly before operating the aerial platform.

Driving

Danger

The aerial platform can tip over if it becomes unstable. Death or serious injury will result from a tip-over accident. Do not drive on ramps that exceed 25 percent grade, or where conditions of the ramp could cause driving to be hazardous.

Use a winch to load and unload the aerial platform on ramps that exceed the gradeability specification for the machine. Refer to “Specifications” pages 21 to 25. A winch may also be used when poor traction, uneven surfaces, or stepped ramp transitions make driving hazardous.

Drive the aerial platform onto the transport vehicle if a winch is not available and the ramp incline is within the grade capability of the aerial platform.

Use the following procedure to drive the aerial platform onto the transport vehicle.

1. Position the transport vehicle so the aerial platform will not roll forward after it is loaded.
2. Chock the vehicle wheels so it cannot roll away from the ramp while the aerial platform is loaded.
3. Remove any unnecessary tools, materials, or other loose objects from the platform.

Caution

The extension deck is free to move when the extension handle locks are disengaged. Personal injury may result from accidentally extending or retracting the deck. Make certain both extension handle locks are fully engaged when the deck is extended in the working position and when it is stowed. Do not attempt to extend or retract the platform unless the aerial platform is on a level surface.

4. Fully retract the platform extension deck and ensure that it is secured in position, with the latch handle locks fully engaged. Fully lower the platform.
5. Drive the aerial platform to the foot of the loading ramp with the front wheels nearest the ramp. Make sure the aerial platform is centered with the ramps and that the steering wheels are straight.
6. On S3220E/S3226E/S4726E/S4732E machines, place the drive range switch in low (turtle) for climbing or descending a ramp.
7. Drive the aerial platform on or off the transport vehicle in a straight line through the grade transitions with minimal turning.

Hoisting

Use a four point sling arrangement attached to the lifting lugs when hoisting the aerial platform. Machine damage can occur if the sling is attached anywhere else.

Warning

The potential for an accident increases when the aerial platform is lifted using improper equipment and/or lifting techniques. Death or serious injury could result from such accidents. Use proper equipment and lifting techniques when lifting the aerial platform.

Know the weight of the aerial platform and the capacity of the lifting devices before hoisting.

- Lifting devices include the hoist or crane, chains, straps, cables, hooks, sheaves, shackles, slings, and other hardware used to support the machine.
- The empty vehicle weight is stamped on the serial number placard and is listed in the machine specifications.

The user assumes all responsibility for:

- Making sure the equipment used is capable of supporting the weight of the aerial platform.
- Making sure all manufacturer’s instructions and warnings, regulations and safety rules of their employer and/or any state or federal law are followed.

Use the following procedure to hoist the aerial platform onto the transport vehicle:

1. Properly stow the aerial platform.
2. Inspect the front lifting lugs and the rear lifting lugs to make sure they are free of cracks and are in good condition. There are two lugs on the rear of the chassis and two on the front. Have any damage repaired by a qualified service technician before attempting to hoist the machine.
3. Remove all personnel, tools, materials, or other loose objects from the platform.
4. Connect the chains or straps to the lifting lugs using bolted shackles. Hooks that fit properly in the lugs and that have latching mechanisms to prevent them from falling out under a slack line condition may also be used.

Do not run the sling cable through the lifting lugs.

- Cable damage and/or failure can result from the cable contacting the sharp corners of the lug.
- There is no effective way of putting a corner protector in the hole of the lug.

Storage

No service is required when storing, or removing the machine from service, for less than one week.

If the machine functions are not cycled for longer than one week, grease exposed cylinder rods with a light, white lithium grease and periodically charge the batteries.

Maintenance

⚠Warning

Always block the elevating assembly whenever it is necessary to perform maintenance while the platform is elevated.

Hydraulic Fluid

The hydraulic fluid reservoir is located in the hydraulic tray. Refer to Figure 5.

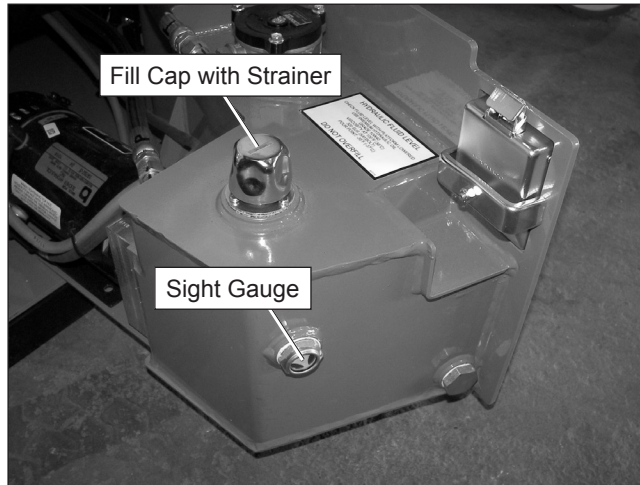

Figure 5 – Hydraulic Fluid Reservoir

Note

Never add fluid if the platform is elevated.

Check Hydraulic Fluid

1. Make sure that the platform is fully lowered.
2. Visually check to make sure the fluid is visible in the sight gauge.
3. If necessary, remove the filler cap and add fluid of the proper type. Replace the cap making sure it is tightly in place. Refer to the machine specifications.

Battery Maintenance

⚠Warning

Hazard of explosive gas mixture. Keep sparks, flame, and smoking material away from batteries.

Always wear safety glasses when working near batteries.

Battery fluid is highly corrosive. Thoroughly rinse away any spilled fluid with clean water.

Always replace batteries with manufacturer approved replacements.

- Check the battery fluid level daily, especially if the machine is being used in a warm, dry climate.
- If electrolyte level is lower than 6 mm (¼") above the plates add distilled water only. DO NOT use tap water

with high mineral content, as it will shorten battery life.

- Keep the terminals and tops of the batteries clean.
- Refer to the Service Manual to extend battery life and for complete service instructions.

⚠Warning

Always use manufacturer approved replacement parts.

Battery Charging

Charge the batteries at the end of each work shift or sooner if the batteries have been discharged.

⚠Warning

Charge the batteries in a well ventilated area.

Do not charge the batteries when the machine is near a source of sparks or flames.

Permanent damage to the batteries will result if the batteries are not immediately recharged after discharging.

Never disconnect the cables from the batteries when the charger is operating.

Keep the charger dry.

Use the following procedure to charge the batteries.

1. The battery disconnect switch is at the rear of the chassis, below the entry step. Turn the battery disconnect switch off.
2. Check the battery water level. Add water to individual cells only if the plates are exposed. Replace the battery caps.
3. Plug the charger into a properly grounded AC outlet using a 3 conductor, 12 gauge or larger extension cord. The extension cord must be as short as possible and in good electrical condition.
4. Leave the charger plugged in until it shuts itself off.
5. Unplug the extension cord after the charger turns itself off. Allow the batteries to cool off after charging.
6. Check the battery water level. Add water to individual cells only if the plates are exposed. Replace the battery caps.

Inspection and Maintenance Schedule

Caution

Frequency and extent of periodic examinations may depend on national regulations.

The Complete Inspection consists of periodic visual and operational checks, along with periodic minor adjustments that assure proper performance. Daily inspection will prevent abnormal wear and prolong the life of all systems. The inspection and maintenance schedule should be performed at the specified intervals and after prolonged periods of storage before returning the machine to service. Inspection and maintenance shall be performed by personnel who are trained and familiar with mechanical and electrical procedures.

Warning

Before performing preventative maintenance, familiarize yourself with the operation of the machine. Always block the elevating assembly whenever it is necessary to perform maintenance while the platform is elevated.

The daily preventative maintenance checklist has been designed for machine service and maintenance. Please photocopy the Daily Preventative Maintenance Checklist and use the checklist when inspecting the machine.

Daily Preventative Maintenance Checklist

Daily Preventative Maintenance Checklist

Preventative Maintenance Report

Date: _____

Serial No: _____

Owner: _____

Serviced By: _____

Model No: _____

Item	Inspect For	Y	N	R
Operator's Manual	In manual holder, all pages readable and intact			
Electrical System				
Battery fluid level	Proper level			
Battery terminals	Clean, connectors tight			
Battery charger	Proper operation			
Cables and wiring harness	No wear or physical damage			
Hydraulic System				
Fluid level	Visible on dipstick with platform stowed			
Hoses, tubes and fittings	No leaks, all fittings tight			
Free-wheeling valve	Fully closed			
Diagnostic Center Display	Displays operating time/battery power			
Tires and Wheels	Good condition			
Ground Strap	In place and securely fastened			
Lower Control Station				
Operating controls	Proper operation			
Emergency stop	Shuts off lower controls/proper operation			
Lowering alarm and interrupt	Sounds when platform lowers/proper operation			
Pothole Protection Interlock	Proper operation			
Emergency Lowering	Proper operation			
Safety Prop	No damage or deformation			
Flashing Light	Proper operation			
Structures				
Weldments – Chassis, platform, etc.	Welds intact, no damage or deformation			
Rollers and slide blocks	In place, no damage or deformation			
Fasteners	In place, tight, and no damage			
Upper Control Station				
Guardrail system	Welds intact, no damage or deformation All fasteners in place, no loose or missing parts			
Platform extension/latch handles	Proper operation, no damage or deformation			
Brakes	Proper operation			
Operating controls	Proper operation			
Emergency stop	Shuts off upper controls			
Lowering alarm and interrupt	Sounds when platform lowers/proper operation			
Drive motion alarm	Sounds when aerial platform drive function is operated			
Battery condition indicator	Proper operation			
Horn	Sounds when activated			
Placards and Decals	In place and readable			

Maintenance Table Key: Y = Yes/Acceptable, N = No/Not Acceptable, R = Repaired/Acceptable

General Specifications – S3219E

Aerial Platform

Working height	7.6 m (25')
Maximum platform height	5.8 m (19')
Turning radius	
Inside	10.16 cm (4")
Outside	1.63 m (64.25")
Wheelbase	1.32 m (52")
Ground clearance	
Pothole protector raised	6.68 cm (2.63")
Pothole protector lowered	1.9 cm (0.75")
Maximum wheel load	846 kg (1,860 lbs)
Maximum ground pressure	15.2 kg/cm ² (218 psi)
Weight, EVW	
Approximate	1564 kg (3,440 lbs)
Maximum allowable manual force (side pull)	
Indoors	445 N (100 lbs)
Outdoors	222 N (50 lbs)
Stowed width	81.3 cm (32")
Stowed length	1.79 m (70.4")
With step removed	1.73 m (68.25")
Stowed height	2.09 m (82.3")
With rails folded	1.65 m (65")

Platform

Dimensions	
Main	71.6 cm x 161.9 cm (28.25" x 63.75")
Extension	71.6 cm x 91.4 cm (28.25" x 36")
Total length with extension	253.4 cm (99.75")
Guardrail height	1.1 m (43.3")
Toeboard height	15.2 cm (6")
Rated work load	
Total	250 kg (550 lb)
Extension	113 kg (250 lb)
Maximum number of occupants	1 outdoors 2 indoors

Function Speed

Platform raise	12 to 20 seconds
Platform lower	20 to 26 seconds
High Drive	
Platform lower than 1.8 m (6')	0 to 3.2 km/h (0 to 2 mph)
Low Drive	
Platform higher than 1.8 m (6')	0 to 0.6 km/h (0 to 0.4 mph)

Drive System

Standard	Two-wheel drive
Gradeability	25%
Maximum drive height	5.8 m (19')

Drive/Lift Level Sensor Interlock

Side-to-side	1.5 degrees
Front-to-rear	4 degrees

Tires

Nonmarking solid rubber 30.5 cm x 10.2 cm (12" x 4")

Electrical System

Voltage	24 V DC negative chassis ground
Source	Four - 6 V 220 amp hour batteries
Fluid recommended	distilled water
Charger	25 amp
Input	120/240 V

Hydraulic System

Maximum pressure	20,684 kPa (3,000 psi)
Reservoir capacity	11.35 l (3 US gal)
System capacity	13.2 l (3.5 US gal)
Maximum operating temperature	71°C (160°F)
Hydraulic fluid recommended	
Above -12°C (10°F)	ISO VG32
Below -12°C (10°F)	ISO VG15

Ambient Air Temperature Operating Range

Celsius	-18°C to 43°C
Fahrenheit	0°F to 110°F

Maximum Wind Speed

Gust or steady	12.5 m/s (28 mph)
----------------	-------------------

Vibration

less than 2.5 m/sec²

Sound Pressure Level

At work station	below 70 dB(A)
-----------------	----------------

Group Classification

Heavy Duty – intended life	100,000 load cycles
----------------------------	---------------------

Specifications

General Specifications – S3220E

Aerial Platform

Working height	7.9 m (26')
Maximum platform height	6.1 m (20')
Turning radius	
Inside	76.2 cm (30")
Outside	2.36 m (93")
Wheelbase	1.77 m (69.72")
Ground clearance	
Pothole protector raised	9.53 cm (3.75")
Pothole protector lowered	1.9 cm (0.75")
Maximum wheel load	932 kg (2,050 lbs)
Maximum ground pressure	15.0 kg/cm ² (215 psi)
Weight, EVW	
Approximate	2045 kg (4,500 lbs)
Maximum allowable manual force (side pull)	
Indoors	445 N (100 lbs)
Outdoors	222 N (50 lbs)
Stowed width	81.3 cm (32")
Stowed length	2.3 m (90.6")
With step removed	2.25 m (88.7")
Stowed height	2.16 m (85.25")
With rails folded	1.72 m (67.75")

Platform

Dimensions	
Main	71.6 cm x 214.3 cm (28.5" x 84.38")
Extension	71.6 cm x 91.4 cm (28.25" x 36")
Total length with extension	305.8 cm (102.38")
Guardrail height	1.1 m (43.3")
Toeboard height	15.2 cm (6")
Rated work load	
Total	409 kg (900 lb)
Extension	113 kg (250 lb)
Maximum number of occupants	1 outdoors 2 indoors

Function Speed

Platform raise	12 to 20 seconds
Platform lower	20 to 26 seconds
High Drive	
Platform lower than 1.8 m (6')	0 to 3.2 km/h (0 to 2 mph)
Low Drive	
Platform higher than 1.8 m (6')	0 to 0.6 km/h (0 to 0.4 mph)

Drive System

Standard	Two-wheel drive
Gradeability	25%
Maximum drive height	7.9 m (26')

Drive/Lift Level Sensor Interlock

Side-to-side	1.5 degrees
Front-to-rear	4 degrees

Tires

Nonmarking solid rubber	38.1 cm x 10.2 cm (15" x 4")
-------------------------	------------------------------

Electrical System

Voltage	24 V DC negative chassis ground
Source	Four - 6 V 240 amp hour batteries
Fluid recommended	distilled water
Charger	25 amp
Input	120/240 V

Hydraulic System

Maximum pressure	20,684 kPa (3,000 psi)
Reservoir capacity	17 l (4.5 US gal)
System capacity	19 l (5 US gal)
Maximum operating temperature	71°C (160°F)
Hydraulic fluid recommended	
Above -12°C (10°F)	ISO VG32
Below -12°C (10°F)	ISO VG15

Ambient Air Temperature Operating Range

Celsius	-18°C to 43°C
Fahrenheit	0°F to 110°F

Maximum Wind Speed

Gust or steady	12.5 m/s (28 mph)
----------------	-------------------

Vibration

less than 2.5 m/sec²

Sound Pressure Level

At work station	below 70 dB(A)
-----------------	----------------

Group Classification

Heavy Duty – intended life	100,000 load cycles
----------------------------	---------------------

General Specifications – S3226E

Aerial Platform

Working height	9.8 m (32')
Maximum platform height	7.9 m (26')
Turning radius	
Inside	76.2 cm (30")
Outside	2.36 m (93")
Wheelbase	1.77 m (69.72")
Ground clearance	
Pothole protector raised	9.53 cm (3.75")
Pothole protector lowered	1.9 cm (0.75")
Maximum wheel load	1112 kg (2,450 lbs)
Maximum ground pressure	12.3 kg/cm ² (175 psi)
Weight, EVW	
Approximate	2045 kg (4,500 lbs)
Maximum allowable manual force (side pull)	
Indoors	445 N (100 lbs)
Outdoors	222 N (50 lbs)
Stowed width	81.3 cm (32")
Stowed length	2.3 m (90.6")
With step removed	2.25 m (88.7")
Stowed height	2.30 m (90.6")
With rails folded	1.86 m (73.13")

Platform

Dimensions	
Main	71.6 cm x 214.3 cm (28.5" x 84.38")
Extension	71.6 cm x 91.4 cm (28.25" x 36")
Total length with extension	305.8 cm (102.38")
Guardrail height	1.1 m (43.3")
Toeboard height	15.2 cm (6")
Rated work load	
Total	250 kg (550 lb)
Extension	113 kg (250 lb)
Maximum number of occupants	1 outdoors 2 indoors

Function Speed

Platform raise	12 to 20 seconds
Platform lower	20 to 26 seconds
High Drive	
Platform lower than 1.8 m (6')	0 to 3.2 km/h (0 to 2 mph)
Low Drive	
Platform higher than 1.8 m (6')	0 to 0.6 km/h (0 to 0.4 mph)

Drive System

Standard	Two-wheel drive
Gradeability	25%
Maximum drive height	7.9 m (26')

Drive/Lift Level Sensor Interlock

Side-to-side	1.5 degrees
Front-to-rear	4 degrees

Tires

Nonmarking solid rubber	38.1 cm x 10.2 cm (15" x 4")
-------------------------	------------------------------

Electrical System

Voltage	24 V DC negative chassis ground
Source	Four - 6 V 240 amp hour batteries
Fluid recommended	distilled water
Charger	25 amp
Input	120/240 V

Hydraulic System

Maximum pressure	20,684 kPa (3,000 psi)
Reservoir capacity	17 l (4.5 US gal)
System capacity	19 l (5 US gal)
Maximum operating temperature	71°C (160°F)
Hydraulic fluid recommended	
Above -12°C (10°F)	ISO VG32
Below -12°C (10°F)	ISO VG15

Ambient Air Temperature Operating Range

Celsius	-18°C to 43°C
Fahrenheit	0°F to 110°F

Maximum Wind Speed

Gust or steady	12.5 m/s (28 mph)
----------------	-------------------

Vibration

less than 2.5 m/sec²

Sound Pressure Level

At work station	below 70 dB(A)
-----------------	----------------

Group Classification

Heavy Duty – intended life	100,000 load cycles
----------------------------	---------------------

Specifications

General Specifications – S4726E

Aerial Platform

Working height	9.8 m (32')
Maximum platform height	7.9 m (26')
Turning radius	
Inside	53.3 cm (21")
Outside	2.41 m (95")
Wheelbase	1.77 m (69.72")
Ground clearance	
Pothole protector raised	6.68 cm (2.63")
Pothole protector lowered	1.9 cm (0.75")
Maximum wheel load	1125 kg (2,480 lbs)
Maximum ground pressure	12.3 kg/cm ² (175 psi)
Weight, EVW	
Approximate	1993 kg (4,385 lbs)
Maximum allowable manual force (side pull)	
Indoors	667 N (150 lbs)
Outdoors	222 N (50 lbs)
Stowed width	1.20 m (47")
Stowed length	2.30 m (90.6")
With step removed	2.25 m (88.7")
Stowed height	2.29 m (90.2")
With rails folded	1.85 m (72.88")

Platform

Dimensions	
Main	109.2 cm x 214.3 cm (43" x 84.38")
Extension	109.2 cm x 121.9 cm (43" x 48")
Total length with extension	336.2 cm (132.38")
Guardrail height	1.1 m (43.3")
Toeboard height	15.2 cm (6")
Rated work load	
Total	454 kg (1,000 lb)
Extension	113 kg (250 lb)
Maximum number of occupants	1 outdoors 3 indoors

Function Speed

Platform raise	12 to 20 seconds
Platform lower	20 to 26 seconds
High Drive	
Platform lower than 1.8 m (6')	0 to 3.2 km/h (0 to 2 mph)
Low Drive	
Platform higher than 1.8 m (6')	0 to 0.6 km/h (0 to 0.4 mph)

Drive System

Standard	Two-wheel drive
Gradeability	25%
Maximum drive height	7.9 m (26')

Drive/Lift Level Sensor Interlock

Side-to-side	2 degrees
Front-to-rear	4 degrees

Tires

Nonmarking solid rubber 38.1 cm x 12.7 cm (15" x 5")

Electrical System

Voltage	24 V DC negative chassis ground
Source	Four - 6 V 240 amp hour batteries
Fluid recommended	distilled water
Charger	25 amp
Input	120/240 V

Hydraulic System

Maximum pressure	20,684 kPa (3,000 psi)
Reservoir capacity	17 l (4.5 US gal)
System capacity	19 l (5 US gal)
Maximum operating temperature	71°C (160°F)
Hydraulic fluid recommended	
Above -12°C (10°F)	ISO VG32
Below -12°C (10°F)	ISO VG15

Ambient Air Temperature Operating Range

Celsius	-18°C to 43°C
Fahrenheit	0°F to 110°F

Maximum Wind Speed

Gust or steady	12.5 m/s (28 mph)
----------------	-------------------

Vibration

less than 2.5 m/sec²

Sound Pressure Level

At work station	below 70 dB(A)
-----------------	----------------

Group Classification

Heavy Duty – intended life	100,000 load cycles
----------------------------	---------------------

General Specifications – S4732E

Aerial Platform

Working height	11.6 m (38')
Maximum platform height	9.8 m (32')
Turning radius	
Inside	53.3 cm (21")
Outside	2.41 m (95")
Wheelbase	1.77 m (69.72")
Ground clearance	
Pothole protector raised	6.68 cm (2.63")
Pothole protector lowered	1.9 cm (0.75")
Maximum wheel load	1329 kg (2,928 lbs)
Maximum ground pressure	12.3 kg/cm ² (175 psi)
Weight, EVW	
Approximate	2425 kg (5,335 lbs)
Maximum allowable manual force (side pull)	
Indoors	445 N (100 lbs)
Outdoors	222 N (50 lbs)
Stowed width	1.20 m (47")
Stowed length	2.30 m (90.6")
With step removed	2.25 m (88.7")
Stowed height	2.39 m (94.2")
With rails folded	1.95 m (76.88")

Platform

Dimensions	
Main	109.2 cm x 214.3 cm (43" x 84.38")
Extension	109.2 cm x 121.9 cm (43" x 48")
Total length with extension	336.2 cm (132.38")
Guardrail height	1.1 m (43.3")
Toeboard height	15.2 cm (6")
Rated work load	
Total	350 kg (770 lb)
Extension	113 kg (250 lb)
Maximum number of occupants	1 outdoors 2 indoors

Function Speed

Platform raise	12 to 20 seconds
Platform lower	20 to 26 seconds
High Drive	
Platform lower than 1.8 m (6')	0 to 3.2 km/h (0 to 2 mph)
Low Drive	
Platform higher than 1.8 m (6')	0 to 0.6 km/h (0 to 0.4 mph)

Drive System

Standard	Two-wheel drive
Gradeability	25%
Maximum drive height	9.8 m (32')

Drive/Lift Level Sensor Interlock

Side-to-side	2 degrees
Front-to-rear	4 degrees

Tires

Nonmarking solid rubber 38.1 cm x 12.7 cm (15" x 5")

Electrical System

Voltage	24 V DC negative chassis ground
Source	Four - 6 V 240 amp hour batteries
Fluid recommended	distilled water
Charger	25 amp
Input	120/240 V

Hydraulic System

Maximum pressure	20,684 kPa (3,000 psi)
Reservoir capacity	17 l (4.5 US gal)
System capacity	19 l (5 US gal)
Maximum operating temperature	71°C (160°F)
Hydraulic fluid recommended	
Above -12°C (10°F)	ISO VG32
Below -12°C (10°F)	ISO VG15

Ambient Air Temperature Operating Range

Celsius	-18°C to 43°C
Fahrenheit	0°F to 110°F

Maximum Wind Speed

Gust or steady	12.5 m/s (28 mph)
----------------	-------------------

Vibration

less than 2.5 m/sec²

Sound Pressure Level

At work station	below 70 dB(A)
-----------------	----------------

Group Classification

Heavy Duty – intended life	100,000 load cycles
----------------------------	---------------------

**Local Distributor / Lokaler Vertiebshändler / Distributeur local
El Distribuidor local / Il Distributore locale**

**EUROPE, MIDDLE EAST
AFRICA & ASIA**

PHONE: +44 (0) 845 1550 058

FAX: +44 (0) 845 1557 756

NORTH & SOUTH AMERICA

PHONE: +1 785 989 3000

TOLL FREE: +1 800 255 0317

FAX: +1 785 989 3070

AUSTRALIA

PHONE: +61 1300 700 450

FAX: +61 2 9609 3057

NEW ZEALAND

PHONE: +64 6 3689 168

FAX: +64 6 3689 164



www.snorkellifts.com